

SOLAR SWITCH



charger

- mains on
- bulk
- absorption
- float



- on
- off
- charger only

invert

- invert
- overlo
- low ba
- tempe



NO-BREAK BACK-UP FOR GRID CONNECTED SOLAR SYSTEMS

Introduction: preventing shut down of the PV system in the event of a power outage

A rapidly growing number of houses, farms and other buildings are being fitted with grid connected solar installations. The standard configuration has an important drawback: it is dependent on the grid. If the grid fails, the grid connected inverter shuts down and a total blackout is the result, despite the investment in a solar installation.

The same is true for other grid connected alternative energy solutions, such as wind, water or micro CHP (micro Combined Heat & Power).

Basically, the solution to this problem is to add an inverter/charger and batteries. Several configurations are possible.

The problem: standard PV system shuts down in case of power outage

Figure 1 Standard PV system with two kWh meters used in countries with a feed-in tariff Figure 2 With one kWh meter used in countries without feed-in tariff

In case of a power outage the grid inverter will shut down and the house will be "in the dark".

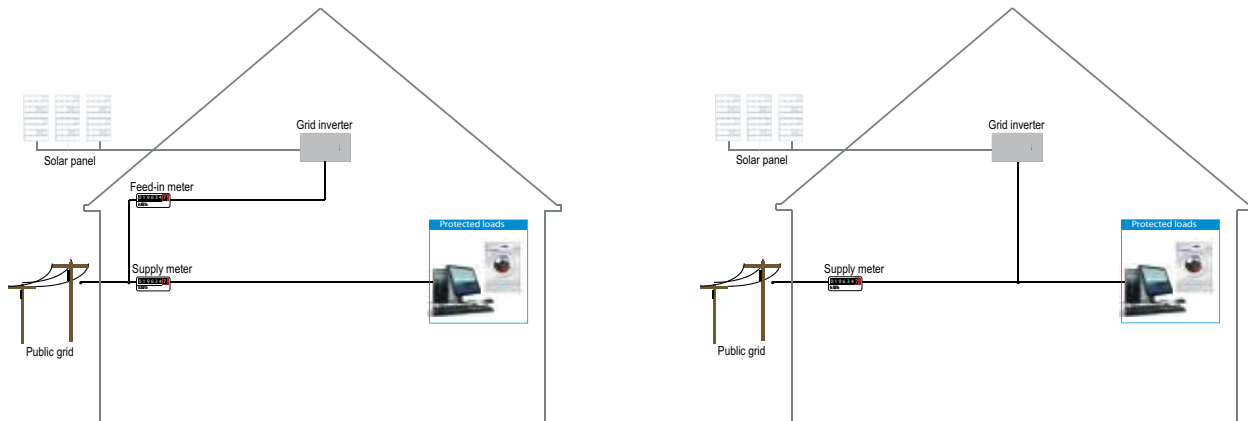



A VICTRON MULTIPLUS OR QUATTRO INVERTER/CHARGER WITH SOLARSWITCH

Figure 3: Two meter system with MultiPlus and SolarSwitch

When the public grid is available, the Victron SolarSwitch will connect the solar inverter directly to the grid.

If the grid fails, the power from the solar inverter will be redirected to the output of the MultiPlus. The MultiPlus replaces the grid and will balance the power mismatch between the load and the solar inverter. A power shortage will be supplemented by the MultiPlus, discharging the battery, and excess power will be used to recharge the battery.

Once the batteries are fully charged, the excess power can be redirected to a water heater (relay not shown), or a dump load (not shown), or the grid inverter can be stopped by slightly changing the output frequency of the MultiPlus (this is a standard feature of the MultiPlus).

In order to prevent the batteries from discharging completely in case of insufficient solar power, some or all loads can be shut down with programmable relays available on the SolarSwitch (not shown).

Figure 3 Two meter system with MultiPlus and SolarSwitch

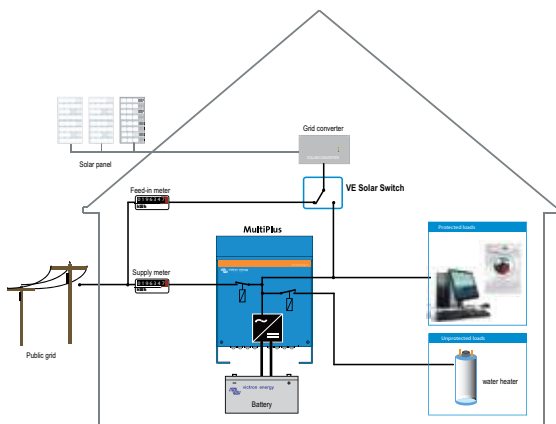

- **Grid impedance**

In some countries grid impedance measurement is required as an additional safeguard against islanding. The output impedance of the MultiPlus will not match the impedance of the grid. Therefore the grid impedance monitoring function of the grid inverter must be switched off for proper functioning of the system. In countries where grid impedance monitoring is required, an additional grid monitoring module (available from Victron Energy) must therefore be inserted between the SolarSwitch and the PV feed-in meter.

- **Limited grid power**

In case of insufficient grid power to support peak loads, the PowerAssist feature of the MultiPlus can be used to supply additional power, taken from the battery. The batteries will be recharged automatically when excess grid power is available.

- **Applicable VE inverter/chargers**

All models MultiCompact, MultiPlus and Quattro with VEBus interface.
All MultiPlus and Quattro models can be configured for parallel and for three phase operation.

- **PV power range**

The peak PV power (or wind or other renewable power) fed back into the MultiPlus or Quattro should never exceed the maximum charging power. In case of a MultiPlus 24/3000/70 for example, the maximum charging power is $24V \times 70A = 1680W$. If the grid inverter "tries" to feed more than 1680W back into the MultiPlus, not all power can be absorbed and the system will shut down.

Figure 4 Alternative 'two + one' meter system with MultiPlus and SolarSwitch

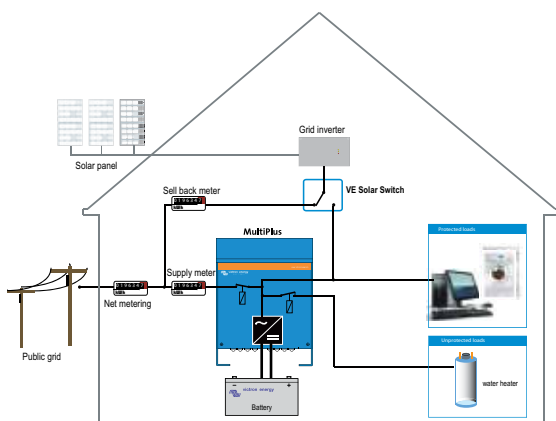



ONE METER SYSTEM WITH PV BACK FEED INTO THE GRID

In this case the solution is very similar to the two meter system. Please see section previous page for a description.

Figure 5 One meter system with MultiPlus

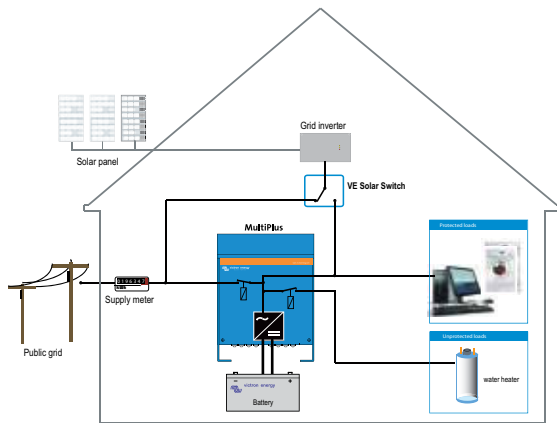
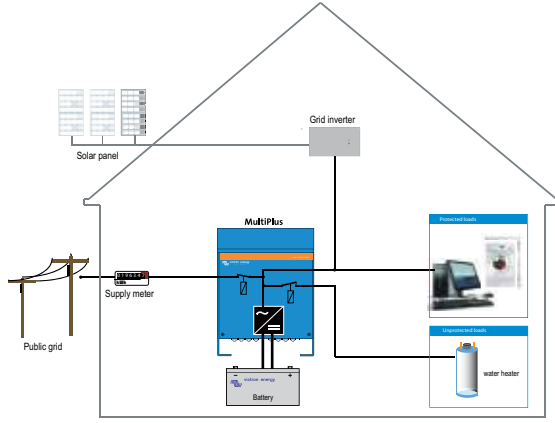

Figure 6 One meter system without PV back feed into the grid

Note: Without back feed into the grid: SolarSwitch not needed



If a genset is available to replace the grid during long outages, the best solution is to install a Quattro instead of a MultiPlus. The Quattro has two inputs to support two AC sources. The Quattro will automatically switch between grid and generator.

Figure 7 Grid connected Two meter system with genset back-up

Figure 8 Off-grid system with genset No SolarSwitch needed, as shown in figure 5

Note: limited generator power

For maximum fuel efficiency the generator should not be oversized but undersized!

In case of insufficient generator power to support peak loads, the PowerAssist feature of the Quattro can be used to supply additional power, taken from the battery. The batteries will be recharged automatically when excess generator power is available.

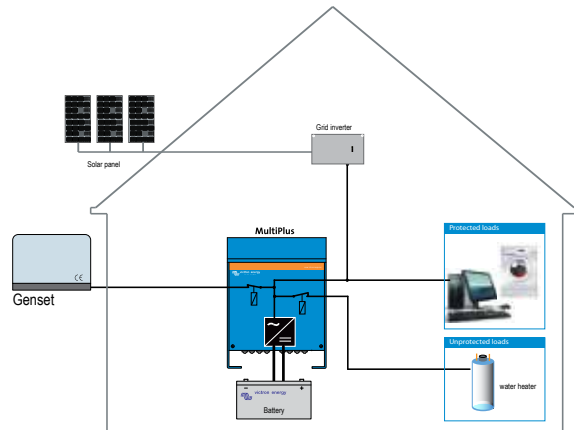
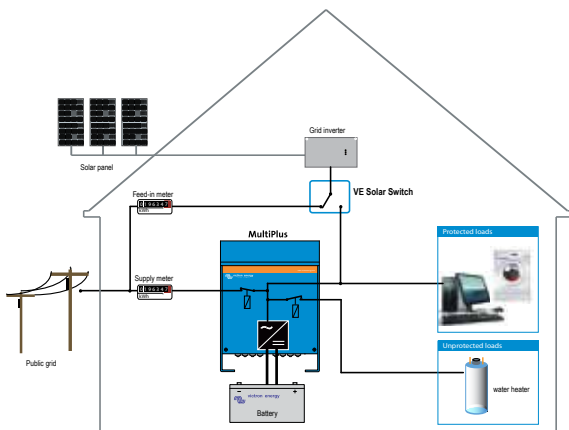

Note: Batteries

In this case the battery is used to store excess PV energy.

There is no need for a SolarSwitch: the grid converter is permanently connected to the output of the MultiPlus.

Any excess PV power can be redirected to a water heater (relay not shown), or a dump load (not shown), or the grid inverter can be stopped by slightly changing the output frequency of the MultiPlus (this is a standard feature of the MultiPlus).

Note: Limited generator power

For maximum fuel efficiency the generator should not be oversized but undersized!

In case of insufficient generator power to support peak loads, the PowerAssist feature of the MultiPlus can be used to supply additional power, taken from the battery. The batteries will be recharged automatically when excess generator power is available.



OPERATING MODES OF AN ON-GRID SYSTEM WITH SOLARSWITCH

- **A. The grid is present**
All loads are supplied by power from the grid. Solar power is directed to the grid.
- **B. Grid failure**
The water heater is disconnected. Solar energy is used to supply the protected loads and/or to recharge the batteries.
- **C. Batteries discharged**
All loads are disconnected. Solar energy is used to recharge the battery. The loads will be reconnected after (partial) recharge of the batteries.

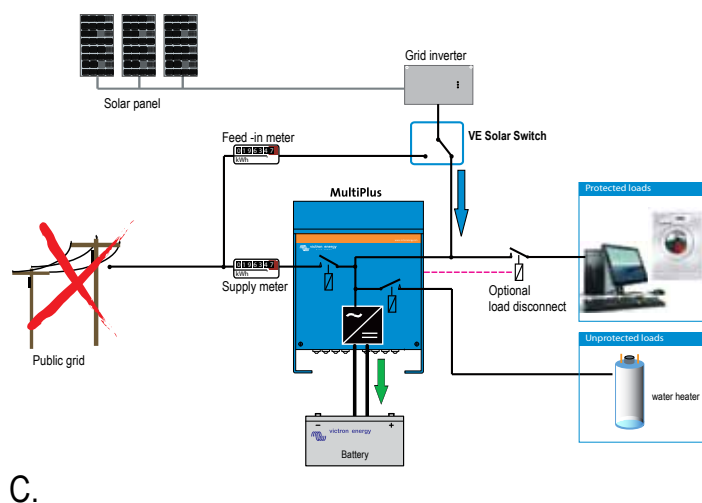
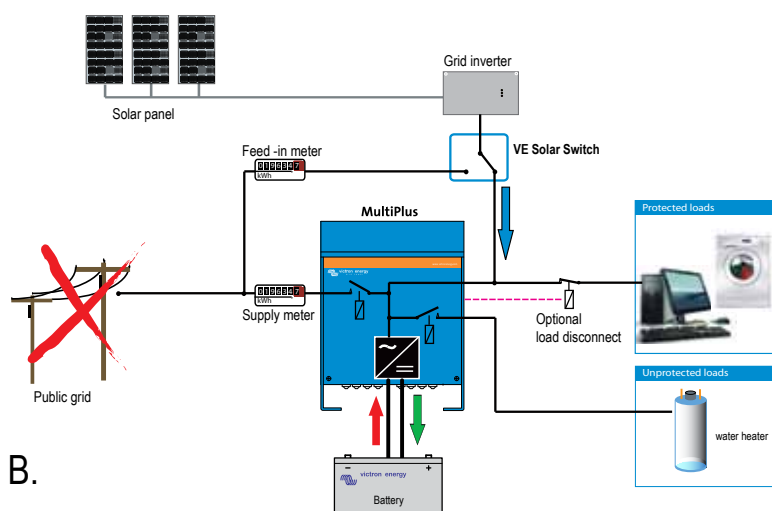
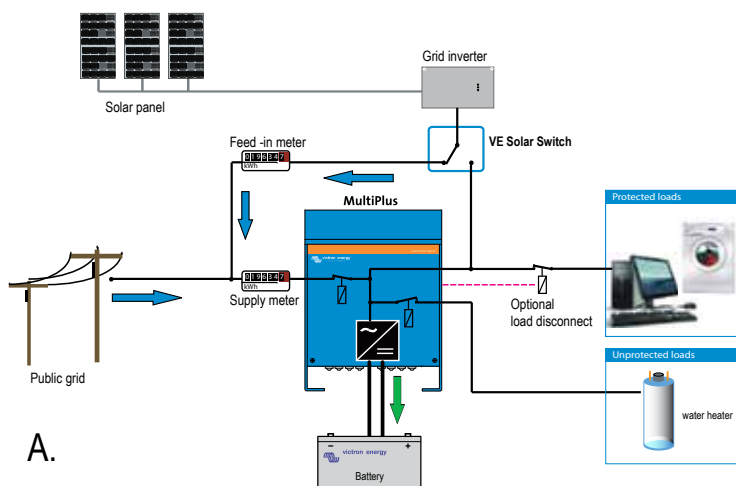



IMPORTANT FEATURES

After installation, the MultiPlus or Quattro is ready for use.

If settings have to be changed, this can be done in a matter of minutes with a new DIP switch setting procedure. Even parallel and 3-phase operation can be programmed with DIP switches: no computer needed!

Alternatively, a VE.Net or Blue Power panel can be used instead of the DIP switches.

Sophisticated software (VE.Bus Quick Configure and VE.Bus System Configurator) is available to configure several new, advanced, features.

Integrated Battery Monitor

At request all Multi's and Quattro's can be fitted with an integrated battery monitor.

Although less accurate than a standalone battery monitor such as for example our BMV600, the integrated Battery Monitor is the ultimate tool to control a generator, or to control connection to the grid in case of a one meter system without PV back feed into the grid.

Features of the Integrated Battery Monitor:

- Battery capacity range from 50Ah to 10.000Ah.
- Resets battery capacity at 85% charged when absorption stage is reached.
(reset is needed to prevent drift in case the generator or the grid is normally disconnected before 100% battery charge is reached)
- Resets battery capacity at 100% charged when float stage is reached.
- Gives a generator start signal (or closes back feed relay to connect to the grid) at a predetermined battery discharge level.
- Gives a generator stop signal (or opens back feed relay to disconnect the grid) after a predetermined time once absorption voltage has been reached.
- Automatic battery equalization.

Notes:

- The Integrated Battery Monitor measures current through the Multi or Quattro only. Any DC battery charge or discharge current from equipment connected directly to the battery is not taken into account.
- VEConfigure software is needed for configuration.

Quiet period: generator off

An internal clock in the Multi or Quattro allows programming of three quiet periods per day, during which the generator will not be started, unless:

- Inverter shutdown due to low battery voltage is imminent.
- Battery is discharged beyond a preset level.
- Load increases beyond a preset level.

Start and stop levels can be set independently for each of the three quiet periods.

Using solar power to the maximum

A quiet period can also be used to make sure that the battery is sufficiently discharged before an important contribution from renewable power sources is expected, this to prevent 'wasting' renewable energy. This can be achieved by allowing a deeper battery discharge level, and by stopping the generator before absorption voltage is reached.

Programmable relay

All Multi's and Quattro's have a programmable relay. The SolarSwitch has three programmable relays.

Application suggestions

Load disconnect for two meter and one meter on-grid installations

The programmable relay can be used to control an optional load disconnect contactor, to shed loads before the Multi shuts down due to low battery voltage (see optional load disconnect in previous page). By disconnecting loads before the low DC voltage trip level is reached, the Multi, and therefore also the grid inverter, will continue to operate, allowing the grid inverter to (partially) recharge the battery.

Alternatively, one of the three programmable relays of the SolarSwitch can be used for the same purpose.

Generator start/stop

The programmable relay can be set to give a start signal if one or more of the following conditions are met:

- Battery % charged drops below a preset value (see integrated battery monitor).
- Battery voltage drops below a preset level.
- Load increases beyond a preset level (with adjustable time delay).
- Battery less than 85% charged shortly before entering a generator quiet period. (this to recharge batteries prior to entering a quiet period)

The programmable relay can be set to give a stop signal if:

- Battery reaches absorption voltage (with adjustable time delay).
- Load decreases below a preset level (with adjustable time delay).
- Generator quiet period begins.

Using solar power to the maximum

In order not 'waste' solar power (or other renewable source), the battery should not be recharged by the grid or a generator just before an important contribution from renewable power sources is expected. One or more quiet periods can be used for this purpose.

Remote monitoring and control: VGR (Victron Global Remote)

The VGR connects either to the GPRS mobile network, or to Ethernet (TCP/IP).

Features:

- Sends SMS messages to a cellular phone: status and alarms.
- Sends data to a user-accessible website. In addition to status and alarms, the website provides graphical display of voltage, current and other important parameters.
- SNMP compatible.



SPECIFICATIONS OF THE SOLARSWITCH

SolarSwitch		
AC inputs (Mains, MultiPlus/Quattro and Solar)	Input voltage range: 187-265 VAC	Input frequency: 45 – 65 Hz
Maximum switch through current (A)	25A	
Maximum power consumption (W)	< 4W	
GENERAL		
Auxiliary programmable Relay (3X) (1)	Max load: 8A 250VAC	
Status LED	1 Blue / 1 Yellow / 1 Red	
Common Characteristics	Operating temp.: -20 to +50°C Humidity (non condensing) : max 95%	
ENCLOSURE		
Common Characteristics	Material & Colour: Housing polyamide 6.6 / green Cover unbreakable polycarbonate / Transparent Protection: IP 20	
230 V AC-connection	Screw terminals 5.2mm ² (10 AWG)	
Auxiliary relay connection	Screw terminals 2.5mm ² (19 AWG)	
Weight (grams)	750	
Dimensions (h x w x d in mm)	88 x 215 x 110	
STANDARDS		
Safety	EN 60335-1, EN 60335-2-29	
Emission / Immunity	EN55014-1, EN 55014-2, EN 61000-3-3	

1) Three programmable relays
AC rating: 230V/4A

Can be programmed with VEConfigure
DC rating: 4A up to 35VDC, 1A up to 60VDC

Application examples: Alarm, generator start or load shedding function

Connecting the SolarSwitch

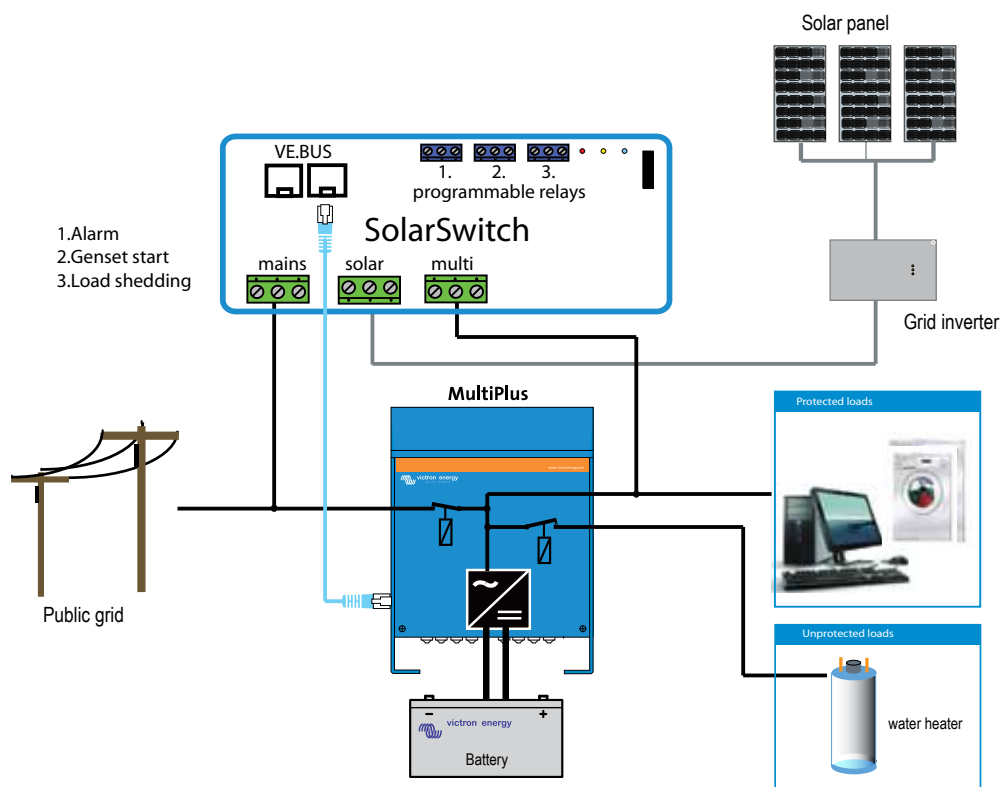



Victron Energy B.V. / De Paal 35
1351 JG Almere / The Netherlands
Phone: +31 (0)36 535 97 00 Fax: +31 (0)36 535 97 40
e-mail: sales@victronenergy.com
www.victronenergy.com

SAL064122020
REV 02
2011-03